

BLA-337

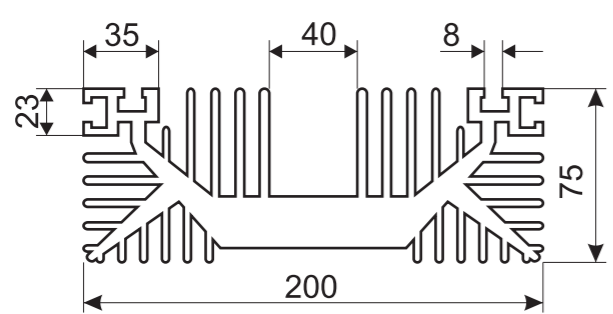

BLA-338

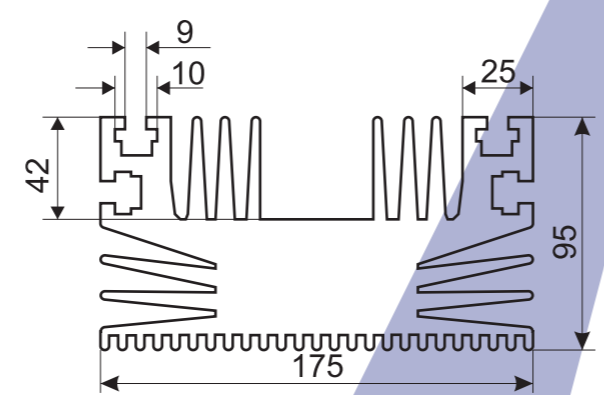

BLA-339

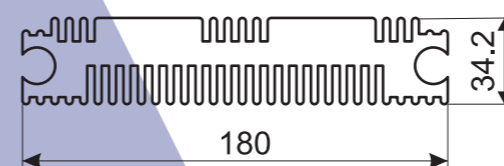

BLA-340

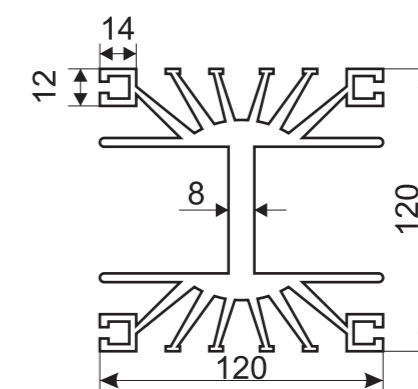

BLA-341

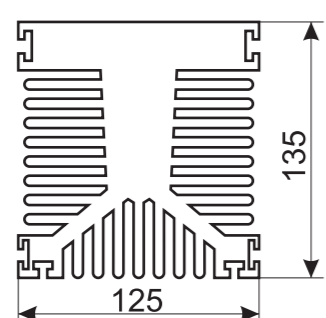

BLA-342

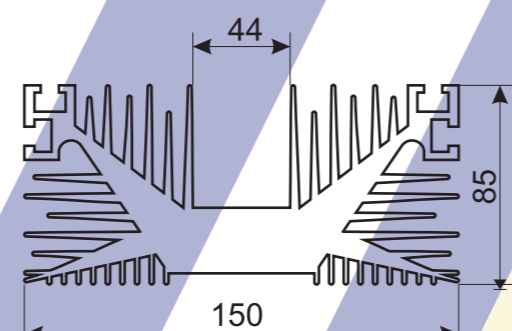

BLA-343

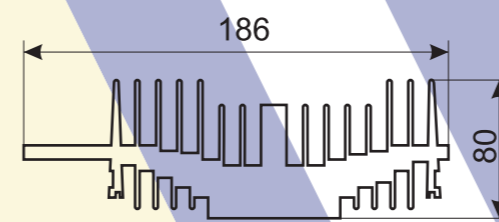

BLA-344

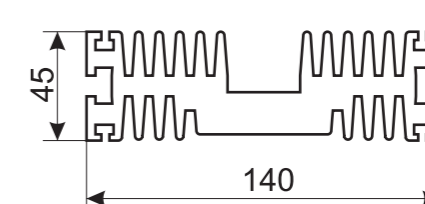

BLA-345

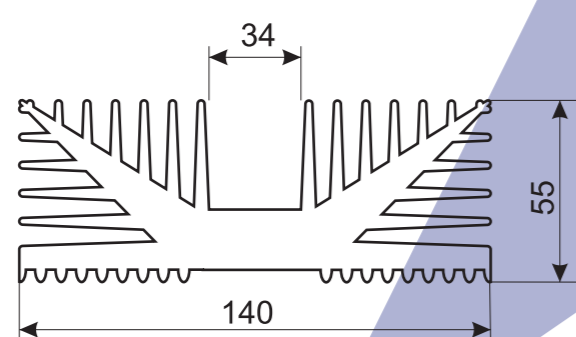

BLA-346

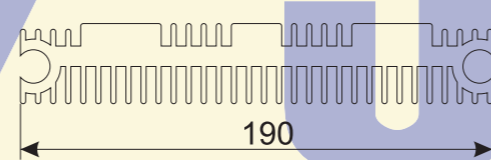

BLA-347

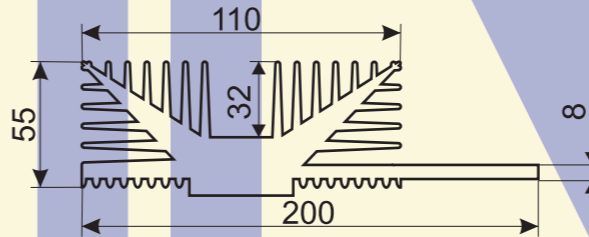

BLA-348

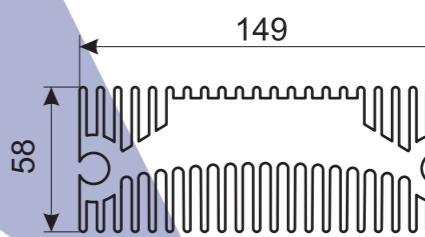

BLA-349

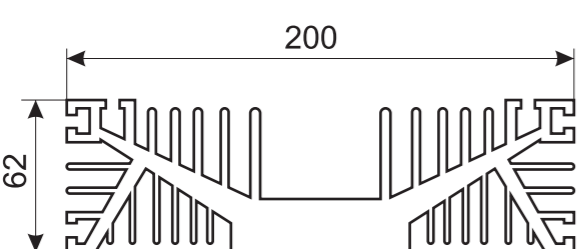

BLA-350

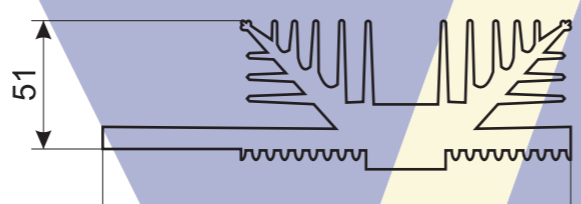

BLA-351

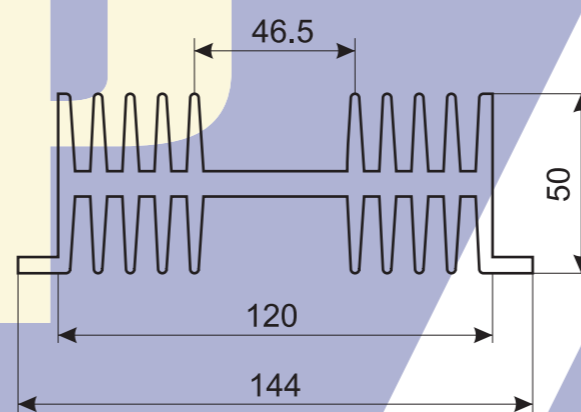

BLA-352

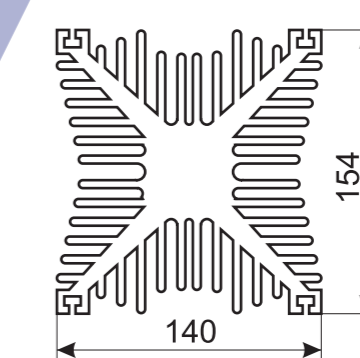

BLA-353

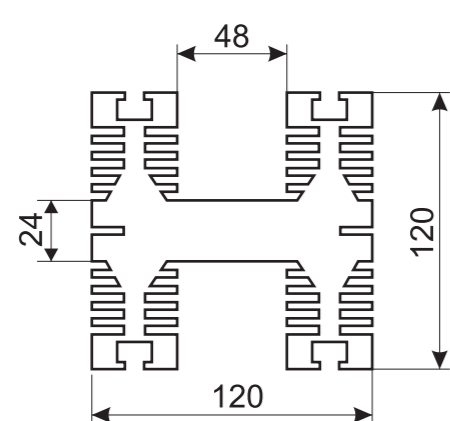

BLA-354

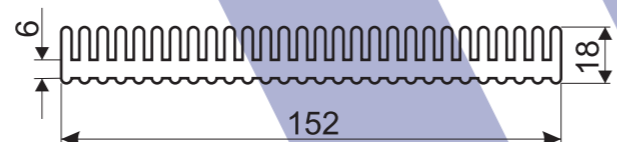

BLA-355

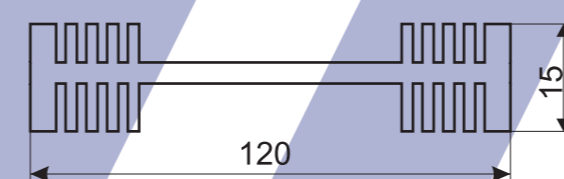

BLA-356

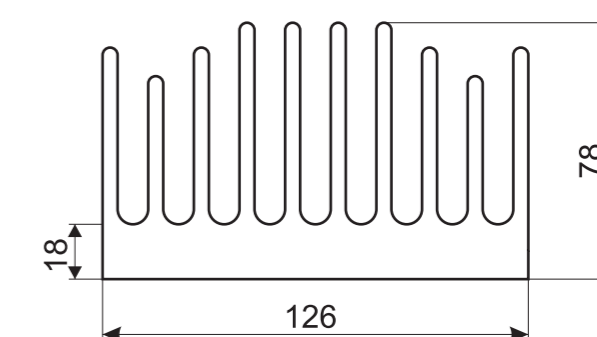

BLA-357

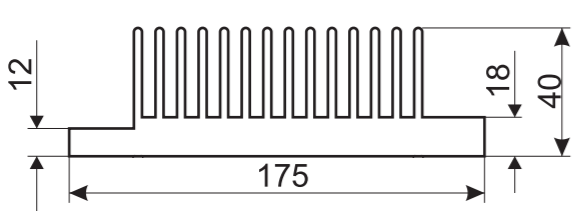

BLA-358



BLA-359

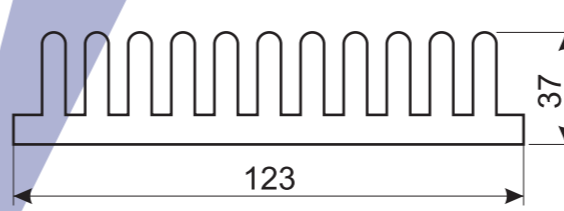

BLA-360

